



Catalogue

2

Single Use Ophthalmic Instruments

rbmedical

Providing the instruments for good health

www.rbmedical.co.uk

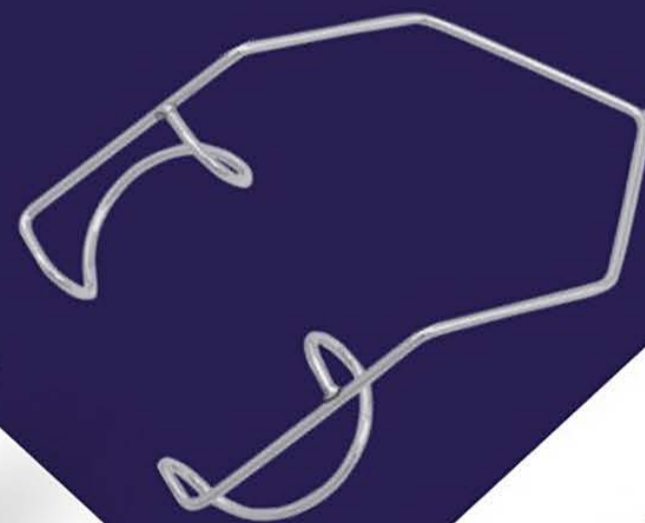



2

Single Use Ophthalmic Instruments

INDEX

Product Group	Page
Speculum	04
Chopper & Manipulators	05
Misc Instruments	06
Alcohol Ring	07
Scissors	08-11
Forceps	12-15
Forceps & Needle Holders	16
Lacrimal Instruments	17
Forceps	18





Single Use
Ophthalmic
Instruments

rbmedical

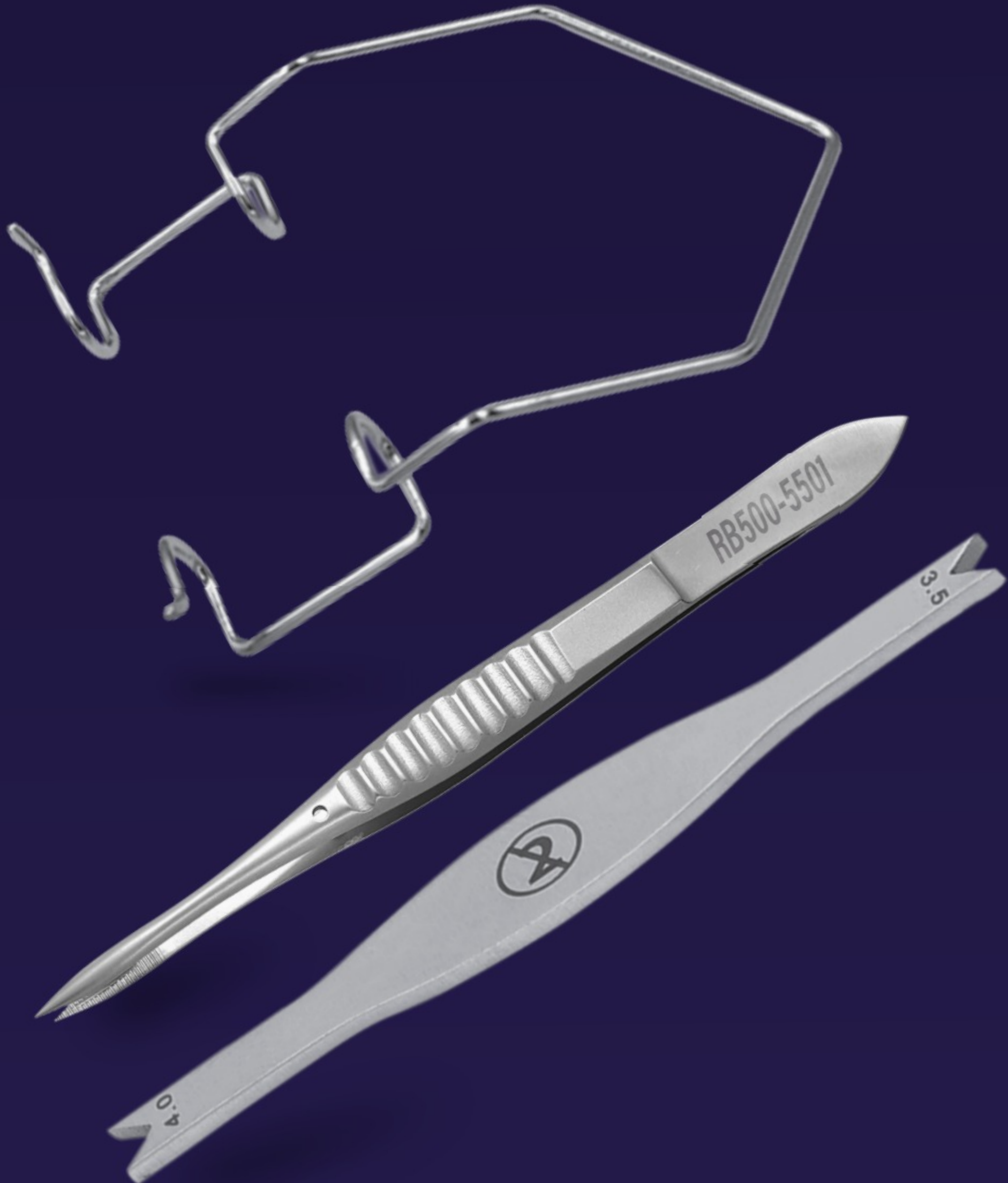

2 Single Use
Ophthalmic
Instruments

Barraquer Speculum

RB200-5000
Curved 10mm blade 4.3cm
RB200-5010
Curved 15mm blade 4.3cm

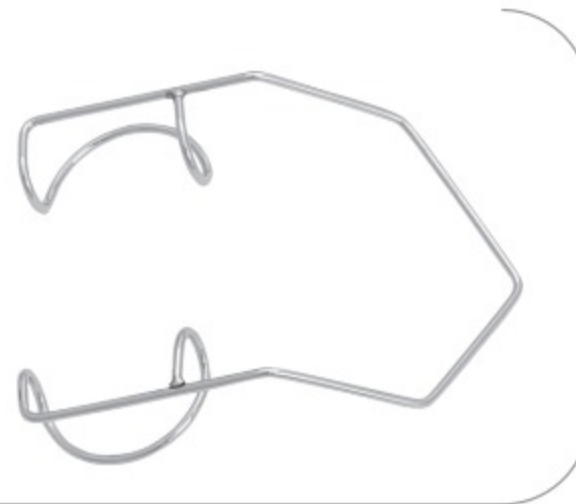

Kratz Speculum

6.5mmx14mm,1mm Dia Wire 4.3cm
RB200-5050
6.5mmx14mm,0.9mm Dia Wire 4.3cm
RB200-5051

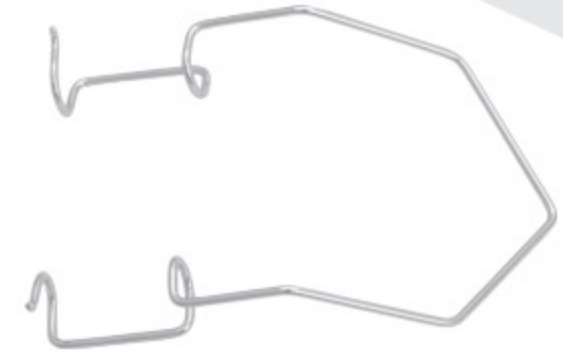

Barraquer Speculum

RB200-6000
Flat blade 10mm 4.3cm
RB200-6010
Flat blade 15mm 4.3cm

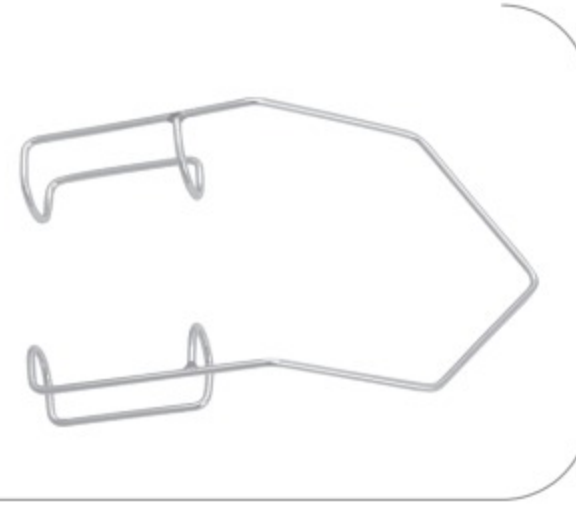

Barraquer Speculum

solid blade 10mm 4.5cm
RB200-5020
solid blade 15mm 4.5cm
RB200-5030



Infant Speculum

4.3mm x 4.3mm Closed Blades,
Ø0.7mm Wire. 25mm Wide 3cm
RB200-5350

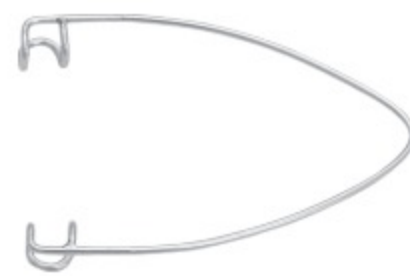

Neonatal Speculum

4.0mm x 10mm Closed Blades,
Ø0.8mm Wire. 25mm Wide
RB200-1261
3.0mm x 7.0mm Closed Blades 3cm
RB200-1262



Kratz Speculum

Kratz-Barraquer Speculum, Curved
6.5mm x 14.5mm Open Curved Blades,
Ø0.9mm Wire. 30mm Wide 4.3cm
RB200-2056

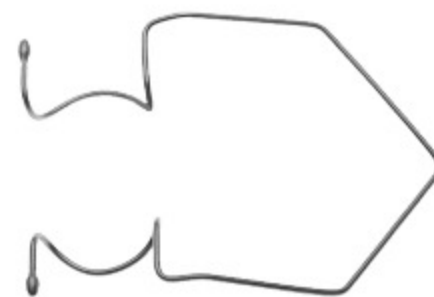

Jaffe Lid Retractors

Jaffe Style wire speculum (Pair)
15mm blades (large) 3.5cm
RB200-8000



Liberman Speculum

RB200-5670 K Wire 10mm 8.5cm
RB200-5671 K Wire 15mm 8.5cm
RB200-5673 Round Wire 14mm for lasik 8.5cm
RB200-5675 V Wire 15mm 8.5cm
RB200-5677 Solid 10mm 8.5cm
RB200-5678 Solid 15mm 8.5cm

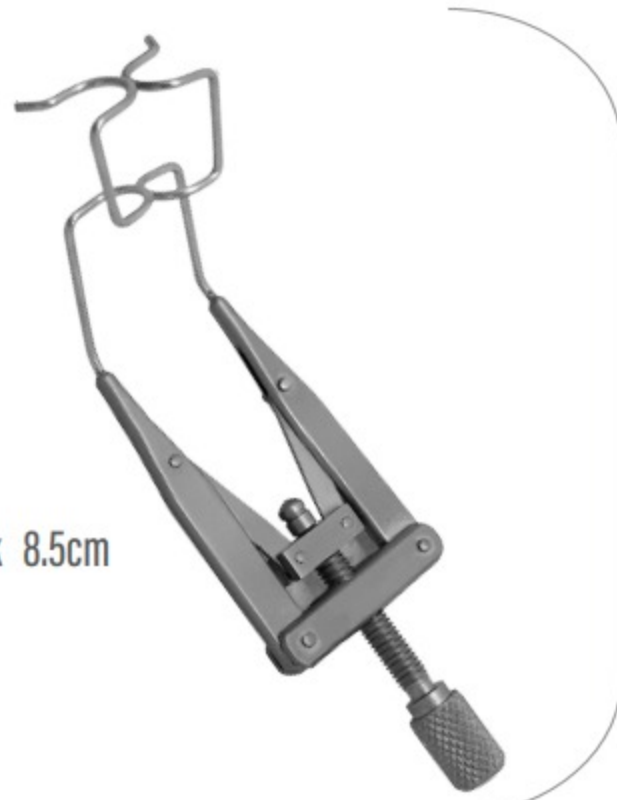

Lancaster Speculum

Eye Speculum
adjustable mechanism
with locking nut
RB200-5600 16mm blades 8cm



Bangerter Speculum

RB200-1230 15mm blades 5cm
RB200-1240 10mm blades 5cm



Bard-Parker Handle

Chuck Handle round, serrated

RB200-1910 10cm

RB200-1920 7.5cm

RB200-1950 # 3

for disposable slot blades 12.5cm



Nucleus Manipulators & Hooks

12cm



Choppers & Manipulators

12cm



Double Ended

12cm



Kirby

Lens Loop and

Muscle Hook 14.5cm

RB300-4105



Flap Elevator

RB300-3131

Blunt tipped 12cm
1 mm spatula

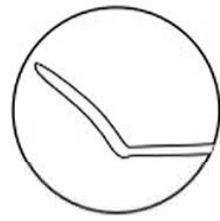

RB300-6060

Epi - Peeler 12cm

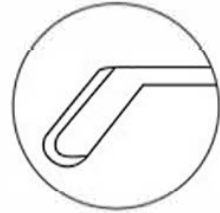

Foreign body spuds

RB300-4000

Golf Club, angled,
lightly rounded tip 12cm

RB300-4050

Francis, angled,
flag shaped tip 12cm

RB300-4100

Ellis, lightly curved and
rounded tip 12cm

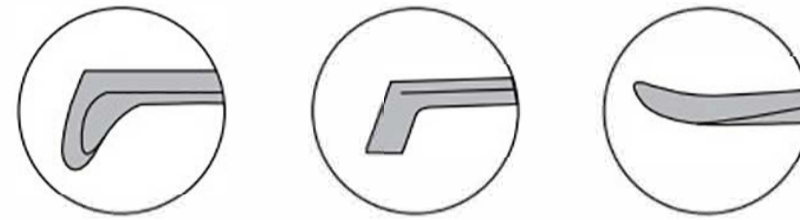

Jameson Muscle Hooks

RB300-6800 Small 13cm

RB300-6810 Large 13cm



Desmarres Lid Retractor

RB300-8210 Size 1, 11mm wide 13cm

RB300-8220 Size 2, 15mm wide 13cm



Schocket Scleral Depressor

RB300-7822 13.5cm

RB300-7825 13.5cm



Mendez

Degree Gauge 12mm I.D. 12cm

RB300-7900



Fine - Thornton

Swivel Fixation Ring blunt teeth

RB300-6161 13mm diameter 12cm

RB300-6163 16mm diameter 12cm



Thornton

Globe Fixation Ring

multiple blunt teeth

RB300-6165 16mm diameter 10cm



Lasek Alcohol Well

Liquid holding well

RB300-1818 Well 7 mm diameter 13cm

RB300-1819 Well 8 mm diameter 13cm

RB300-1820 Well 8.5 mm diameter 13cm

RB300-1821 Well 9 mm diameter 13cm



Lasik Flap Lifter

Combines a 45° angled

sinsky hook and a thin

hook with a tip 10cm

RB300-2538

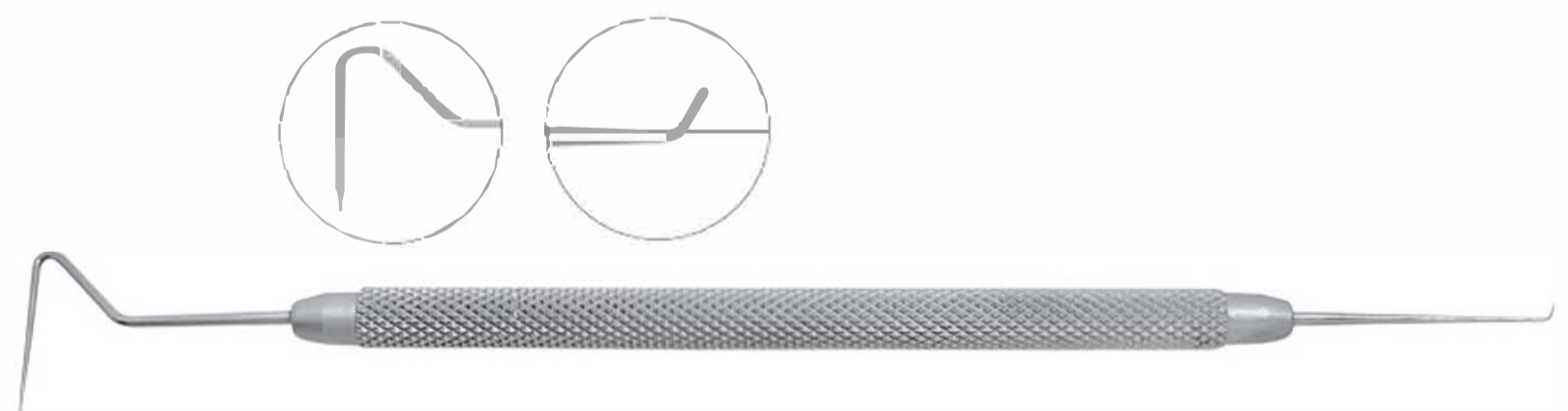

Corneal Trephines Insert

RB300-8048 7mm

RB300-8049 8mm

RB300-8050 9mm

RB300-8051 10mm

RB300-8052 16mm

RB300-8053 18mm

RB300-8054 17mm



Castroveijo Caliper
 RB300-9000 Marking 20mm Str 9cm



Braunstein Gauge
 RB300-0200 3.5/4.0mm 7cm



Corneal Scissors
 Corneal Scissors 12cm
 curved, blunt tips 12cm
 RB400-2220



Westcott Scissors
 Tenotomy Scissors
 blunt tips, medium blades
 curved 12cm
 RB400-3004



Westcott Scissors Dolphin Nose
 RB400-1213 12cm



Westcott Scissors
 Tenotomy Scissors
 blunt tips, curved 12cm
 RB400-3100



Westcott Scissors

Tenotomy Scissors
sharp tips, curved 12cm
RB400-4100



Corneal Scissors

RB400-4300
Corneal Scissors 11.5cm
curved, blunt tips 11.5cm



Vannas Scissors

RB400-5000 Str 5mm Blade 8cm
RB400-5010 Cvd 5mm Blade 8cm
RB400-5050 Str 7mm Blade 8cm
RB400-5060 Cvd 7mm Blade 8cm
RB400-5070 Str 11mm Blade 8cm
RB400-5080 Ang 11mm Blade 8cm



Iris Scissors

RB400-7000B Blunt 9cm
RB400-7010B Blunt 9cm
RB400-7400 Str 11.5cm
RB400-7410 Cvd 11.5cm



Stevens Scissors

RB400-8500 Str 11.5cm
RB400-8510 Cvd 11.5cm



Strabismus Scissors

- RB400-9000 Str b/b 11.5cm
- RB400-9010 Cvd b/b 11.5cm



Dressing Scissors

- RB400-9500 Str S/S 14.5cm
- RB400-9520 Str B/B 14.5cm
- RB400-9530 Cvd B/B 14.5cm
- RB400-9540 Cvd S/S 14.5cm



Stitch Scissors

- RB400-9600 9cm



Moorfield Forceps

- RB500-5500 Standard 11.5cm
- RB500-5501 Micro 11.5cm



Moorfield Dressing Forceps

- RB500-5510 Standard 11.5cm
- RB500-5520 Micro 11.5cm



Iris Forceps

- RB500-4000 Str 0.7mm 10.5cm
- RB500-4010 Cvd 0.7mm 10.5cm
- RB500-4100 Str Teeth 1x2 10.5cm
- RB500-4110 Cvd Teeth 1x2 10.5cm



St Martin Forceps

RB500-3560D with tying 1x2 9.5cm
 RB500-3562D Plain tying 9.5cm



Jewelers Forceps

delicate, straight # 1
 RB500-6510

standard, straight # 3
 RB500-6530

standard, straight # 4 11cm
 RB500-6540

standard, straight # 5 11cm
 RB500-6550

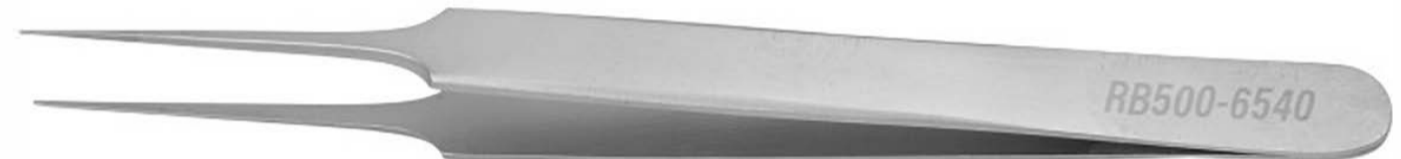

Adson Forceps

RB500-4150 Serrated 1mm 12cm

RB500-4152 Micro Srt 0.5mm

RB500-4170 1x2 Tissue

RB500-4172 1x2 Micro 0.5mm



Utrata Capsulorhexis Forceps

Capsulorhexis Forceps

very delicate

11mm long shanks 10cm

RB500-5081



Curved Capsulorhexis Forceps

Capsulorhexis Forceps

very delicate tips

11mm long 10cm

RB500-5084



Capsulorhexis Forceps Round Bodied
straight shafts.

RB500-5085

45° angled shafts.

Tip to angled length 14 mm 11cm

RB500-5086

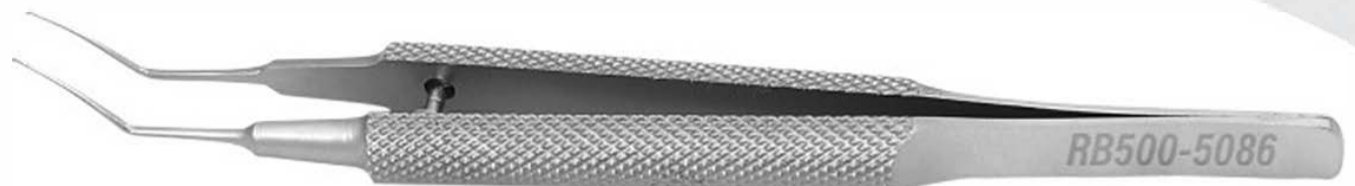
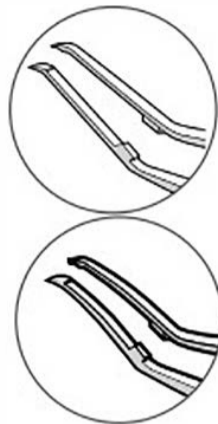

Bishop Harmon Forceps

RB500-3000 Serrated 9cm

RB500-3001 1x2 9cm



Keratoplasty & Corneal Fixation Forceps U Shape

RB500-3250



TUEBINGEN Tying Forceps

RB500-19030 Str 10cm

RB500-19040 Cvd 10cm

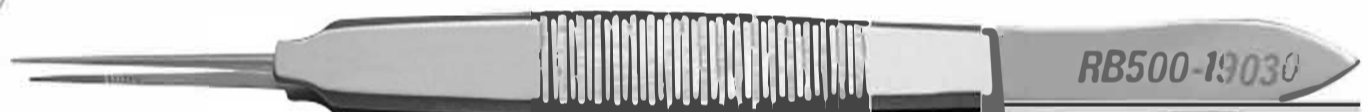
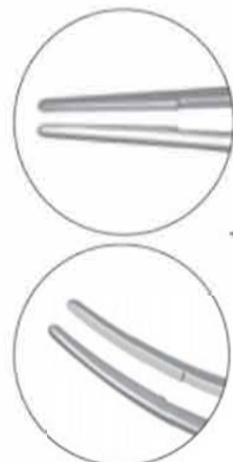

Jaffe Tying Forceps

RB500-5200 Str 6mm Delicate 10.5cm

RB500-5210 Cvd 6mm Delicate 10.5cm

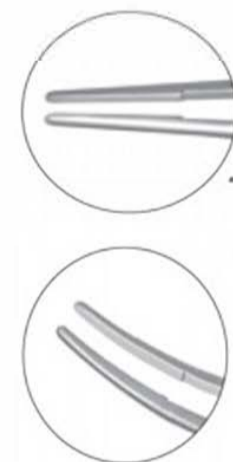

Troutman Forceps

RB500-5400 Str 6mm 10.5cm

RB500-5410 Cvd 6mm 10.5cm



McPherson Forceps

RB500-5000 Str 5mm tying 10cm

RB500-5010 Ang 5mm tying 10cm

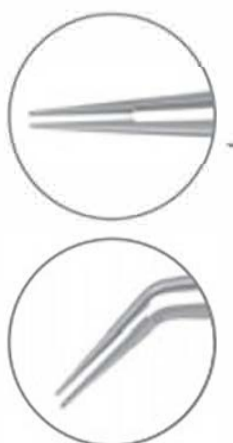

Kelman McPherson Forceps

RB500-5030 Ang 8mm tying 10cm

RB500-5050 Ang 10mm tying 10cm



Swan Neck Forceps (smooth) Instrument

RB500-0035 length 85 mm 11cm



Bonn Forceps

RB500-2000 0.12 1x2 9cm

RB500-2000BL 5mm tying 9cm

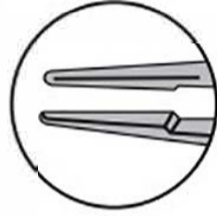
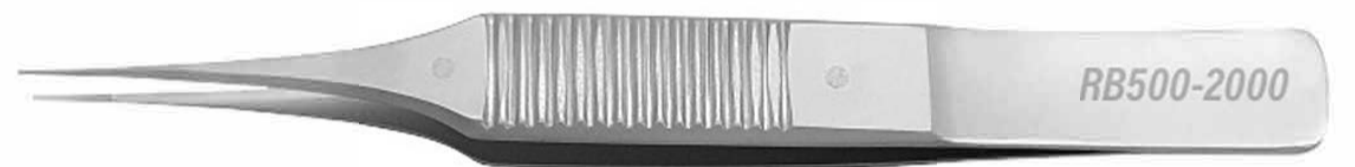
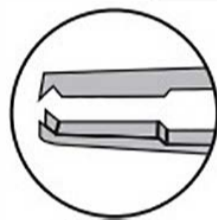

Bonn Forceps

RB500-2020 0.12 1x2 9cm

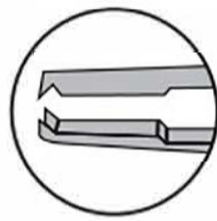

Castroviejo Suturing Forceps

RB500-2510 0.3mm 1x2 10cm

RB500-2540 0.8mm 1x2 10cm

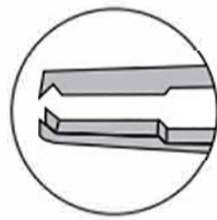

Colibri Forceps

RB500-1520 Tying 1x2, 0.12mm 11cm

RB500-1521 Tying 11cm



Colibri Forceps Notched

RB500-1722 Fine Groove 11cm

Corneal Fine Notched Forceps

RB500-1823 0.2mm notch 11cm

RB500-0071 Tying 110mm Str 11cm

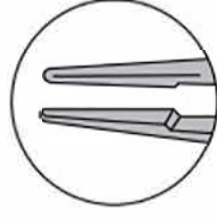

Jayle Corneal Tying Forceps

RB500-0101072 1x2 0.3mm 10.5cm

RB500-0101042 1x2 0.5mm 10.5cm

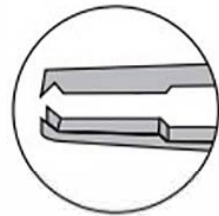

Lister Utility Forceps

RB500-1302 1x2 0.8mm,
6mm Tying Platform, O/L 114mm 10cm

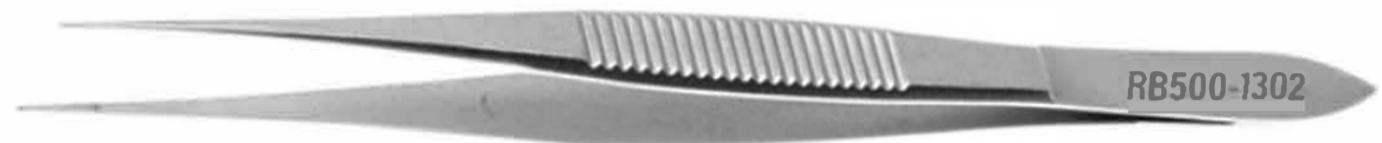
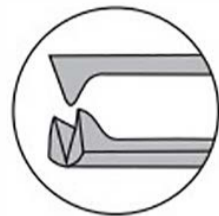

Lens Insertion Forceps

RB500-8220 10cm

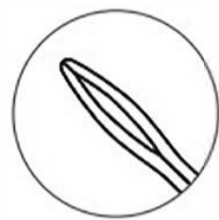

Lasik Flap Forceps

RB500-5059 10cm

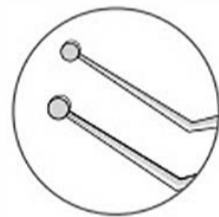

Buratto

LASIK Flap Forceps disc
shaped

serrated jaws

D500-5056 Str 10cm

D500-5058 Cvd 10cm



Barraquer Cilia Forceps

RB500-6000 10cm

RB500-6001 10cm



BEER Cilia Forceps
RB500-9300 11cm



Chalazion Forceps
round
RB500-9450 Lambert, 8mm I.D. 10cm
RB500-9500 Hunt, 12mm I.D. 10cm



Chalazion Forceps
oval
RB500-9600 Francis, 14 x 11mm I.D. medium 9CM
RB500-9650 Desmarres, 20 x 13mm I.D. large 9CM



Corneal Micro Holder
RB600-3030 Cvd 9CM



Barraquer Needle Holder
RB600-13300 With lock 13CM
RB600-13310 Without lock 13CM



Castroviejo Needle Holder
RB600-1510 Str with lock 14CM
RB600-1520 Str without lock 14CM
RB600-1530 Cvd with lock 14CM
RB600-1540 Cvd without lock 14CM

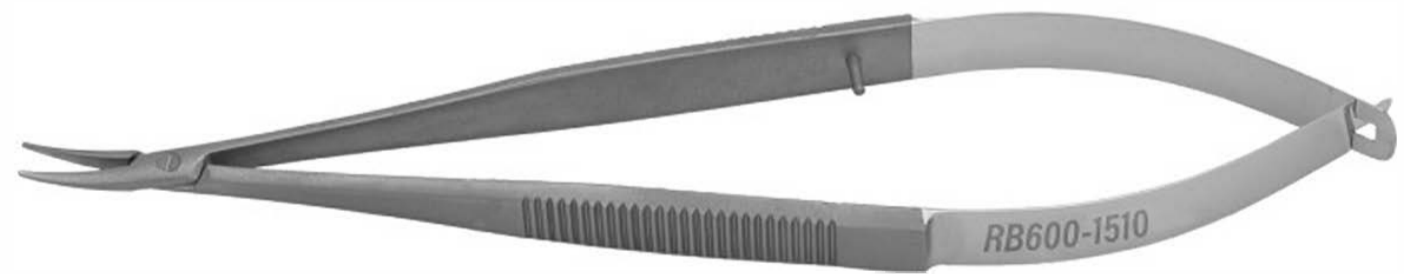

Jaffe Needle Holder
RB600-1130 Without lock 14CM



Barraquer Needle Holder
RB600-1600 Without lock cvd 14cm



Simcoe I/A Cannula
RB700-4300 Simcoe Cannula



Air Injection Cannula
 angled at 5mm
RB700-3500 30 Gauge
RB700-3520 27 Gauge

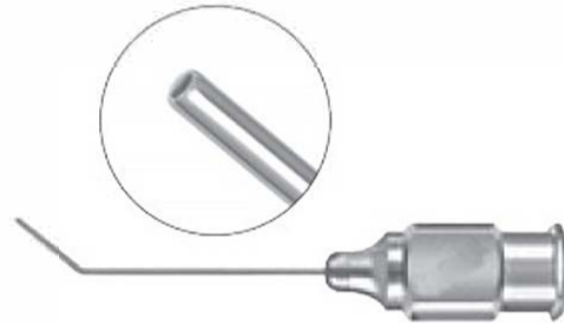

Hydrodissection
 Cannula angled at 8mm
 flat tip, front opening
RB700-5054 25 Gauge

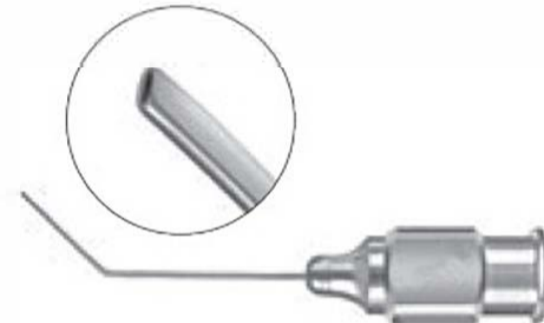

Lacrimal Dilator And Probe
RB700-2100 Double end



Double Curette
RB700-2220 1.5/2mm 15CM
RB700-2210 2.5/3mm 14CM



Double Ended Punctal Dilator
 Double - Ended
RB700-2300 14CM



Punctal Dilator
RB700-3500 Sharp end 12CM
RB700-3520 Blunt end 12CM

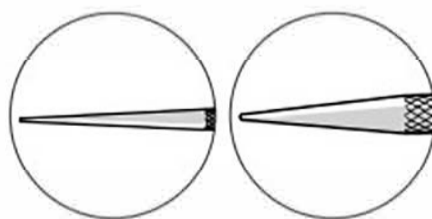

Mayo Needle Holder

RB700-9810 13cm

RB700-9820 16cm

RB700-9830 18cm



Mosquito Forceps

RB700-9900 Str 9cm

RB700-9910 Cvd 9cm

RB700-9940 Str 12.5cm

RB700-9950 Cvd 12.5cm



Kelly Forceps

RB700-9850 14cm

RB700-9851 18cm



Sponge Forceps

RB700-9860 18cm

RB700-9870 25cm



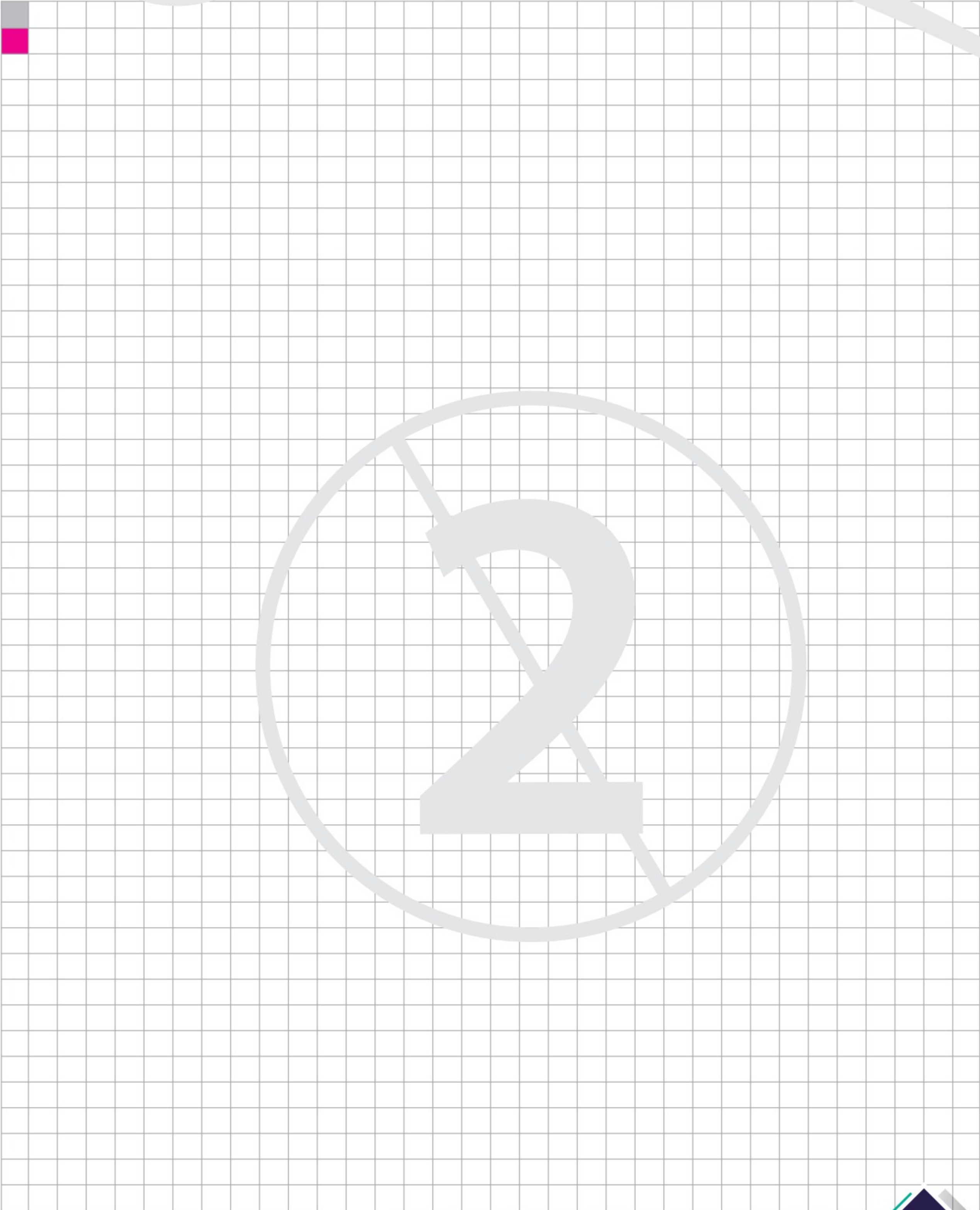

2
Single Use
Ophthalmic
Instruments



RB Medical Engineering Ltd,
Unit 2, Alton Road Industrial Estate,
Ross-on-Wye, Herefordshire, HR9 5NS

+44 (0)1989 563958

Issue V.2 June 2023

